

The processing of jigged ferromanganese fines in a DC arc furnace

K. Bisaka*, G.M. Denton* and J.A.L. Parker**

*Mintek, Randburg, South Africa

** Titaco, Johannesburg, South Africa

Abstract

The APIC jigging process jointly developed by Mintek and Titaco is currently used in South Africa and worldwide to reclaim metallics from crushed ferroalloy slag. The valuable metallic product is not all recovered in saleable size fractions or grades.

The processing of off-spec jigged materials in terms of both size and chemical composition in a DC arc furnace was investigated by Mintek, in order to optimize the overall profitability and material utilization of the jigging process. The pilot plant furnace was operated at power levels up to 1 MW.

It was concluded that a process combining jigging and DC arc furnace smelting would be a viable complement to existing ferromanganese plants to either increase their production or reduce their operating costs.

INTRODUCTION

Ferromanganese alloys are commonly produced in submerged-arc electric furnaces, using carbothermic reduction of manganese ore. This can be done with or without the addition of lime as flux, which is known as the basic and fluxless process, respectively.

Carbothermic production of ferromanganese alloy in submerged-arc electric furnaces is characterized by a marginal loss of about 20 to 40 percent of manganese to the slag and fume¹. Manganese lost to the slag consists of both oxide and metal species. Metal is entrained or entrapped in the oxide elements of the slag. Optimized recovery of manganese to the metal is achieved only in a plant combining the production of both high-carbon ferromanganese and silicomanganese, and based on the fluxless process. This type of plant uses slag from a high-carbon smelting unit as a component of the feed for the production of silicomanganese. This practice increases material utilization and decreases energy consumption compared to the basic process. However, final discarded slags from the

silicomanganese production unit still contain an appreciable amount of entrained metal.

A gravity method to recover entrained metallics was jointly developed by Mintek and Titaco. This method increases further the overall plant recovery of manganese to the alloy.

The APIC jigging process², which uses the action of water at high pressure, separates by density at very high yield, metallics from the remaining oxide of crushed slag. The process is cost-effective since it utilizes water and has a low requirement for energy and labour. This method is currently used in South Africa and worldwide.

However, metallic product from the jigging plant is not all recovered in saleable size fractions and grades; the market for ferromanganese alloys absorbs only lumpy material of sizes above 6mm, sometimes at discounted price for non-conformity to the chemical quality requirements.

Actually, in most of the plants benefiting from the jiggging process, only a fraction of jiggged metal fines (minus 6mm) generated is recycled back to the primary AC furnace since its entire smelting would necessitate that agglomeration be performed at additional costs.

A DC arc furnace is suitable for the direct processing of ferromanganese metal fines without prior briquetting or agglomeration³, and it was therefore possible to investigate the direct production of saleable ferromanganese alloy from the smelting of jiggged metal fines.

Thermodynamic Considerations of the Process

The quality of jiggged material is characterized by its metallics content and chemical analysis. The metallics content increases from fines to lumps where it is assumed to be closer to 100 percent. The chemical analysis, however, depends on several uncontrolled factors linked to the smelting conditions during the production of manganese alloys, and the disposal of different sources of slag in the same location. In most instances the silicon and manganese content does not meet the specification for any carbon ferromanganese alloy; silicon content is higher while manganese is lower.

The smelting of jiggged materials involves the removal of silicon from the metal phase along with an upgrade of manganese, in order to meet the chemical requirements of the market. The physical aspects are addressed with a suitable casting of the final product.

The smelting process progresses towards an equilibrium between metal and slag phases. The metal phase is constituted of the metal portion of the jiggged material while the slag phase includes the slag portion modified with manganese ore and flux (lime). A metal-slag ratio, slag composition, temperature and residence time

characterize this smelting process. In principle, the main reactions are described in [1] and [2], as:

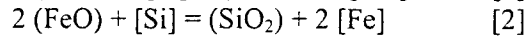
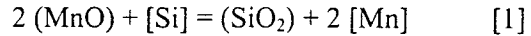

where the parentheses indicate a species present in the slag and the square brackets indicate a species present in the alloy. These are competing reactions which when simplified give:

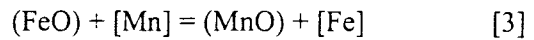

Reaction [3] describes the equilibrium between iron and manganese species in the metal and slag phases following their silicothermic reduction.

The same equilibrium as described by reaction [1] could be applied to both ferromanganese and silicomanganese⁴.

Several authors⁴⁻⁹ have investigated Reaction [1]. Rankin⁹ expressed its equilibrium constant as a factor of apparent equilibrium constant K' and system activity coefficient γ_{sys} :

$$K_1 = K_1' \gamma_{\text{sys}}$$

$$K_1' = \frac{D_{\text{Si}}}{D_{\text{Mn}}^2}$$

$$\gamma_{\text{sys}} = \frac{\gamma_{\text{Mn}}^2 \cdot \gamma_{\text{SiO}_2}}{\gamma_{\text{Si}} \cdot \gamma_{\text{MnO}}^2}$$

$$D_{\text{Mn}} = N_{\text{MnO}} / N_{\text{Mn}}$$

$$D_{\text{Si}} = N_{\text{SiO}_2} / N_{\text{Si}}$$

where N_i is mole fraction and γ_i is the activity coefficient of the species i in the slag or alloy.

The analysis of K_3 shows the importance of the ore manganese grade and Mn/Fe ratio on

the distribution of manganese and iron, between the slag and metal.

Besides the silicothermic reactions described, two reactions are also observed which contribute to manganese and silicon volatilization:

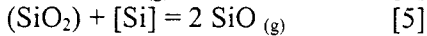

Below 1600°C, the partial pressures of both $\text{Mn}_{(g)}$ and $\text{SiO}_{(g)}$ are quite low and may be neglected⁴.

In practice, volatility of the two species will depend on the driving force which is the difference between the equilibrium and actual partial pressures. The partial pressure decreases with an increase of the volume of gas generated or introduced into the system. This is better illustrated by comparing silicothermic and carbothermic production of manganese alloys with regard to manganese losses to the fume. Any gas generated through reduction or roasting reactions and any gas introduced during smelting will affect to a certain extent the loss of manganese to the fume. Ideally no gas should be introduced or generated.

This paper summarizes the results of testwork smelting of jigged material in a DC arc furnace, performed at Mintek.

DESCRIPTION OF MINTEK'S 5.6 MVA DC ARC FURNACE

Direct-current arc furnaces are suitable for the smelting of fine materials. Mintek has developed and piloted processes for the smelting of ilmenite and chromite fines¹⁰. Other successful Mintek applications of DC arc furnace technology include cobalt slag cleaning, ferronickel, zinc fuming, and magnesium smelting. The benefits of using a DC arc furnace have been listed elsewhere¹⁰⁻¹¹.

The DC arc furnace consists of a single graphite electrode (cathode) positioned above the molten bath. The return electrode,

or anode, consists of multiple steel rods built into the hearth refractories and connected at their lower end to a steel plate which, via radially extending arms, is linked to the furnace shell, and further to the anode cable. The furnace comprises a refractory-lined cylindrical steel shell, and a water-cooled roof lined with an alumina refractory. The outer side walls of the furnace are water-cooled, to protect the refractories by promoting the formation of a freeze lining within the vessel. The roof contains the central entry port for the graphite electrode and up to three equi-spaced side feed ports. A schematic diagram of this arrangement is shown in Figure 1.

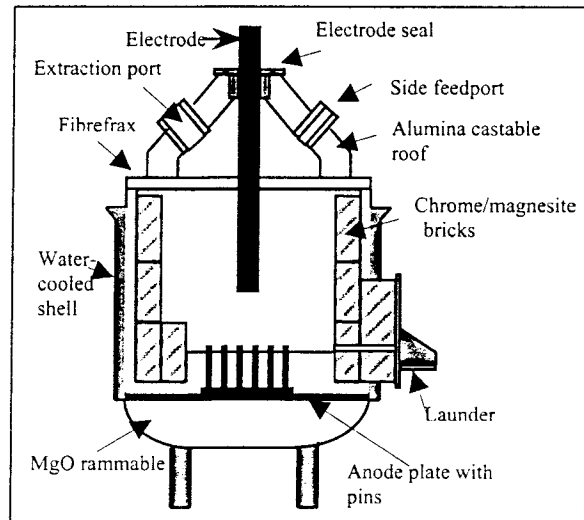

Figure 1: Schematic diagram of a d c - arc furnace

The solid-feed system of the pilot plant comprises a batching plant and a final controlled feeding system. The batching plant consists of feed hoppers mounted on load cells, belt feeders positioned under the hoppers, a pocket elevator, a surge bin, and a screw feeder. The final feeding system is made up of separate centre- and side-feeding arrangements. The centre-feeding configuration uses a screw feeder discharging into a telescopic pipe attached to the hollow graphite electrode.

In the side-feeding arrangement, the feed material is discharged into the furnace ports.

The gas-cleaning system consists of a water-cooled off-gas pipe, a refractory-lined combustion chamber, water-cooled ducting, a radiant cooler, a reverse-pulse bag filter, a fan, and a stack. The condensed fume and dust, which accumulates in the lower conical section of the bag plant, is discharged via screw feeders into bulk bags. This dust would, of course, be recycled back to the furnace in an industrial situation.

The furnace used for re-melting and smelting of the high-carbon ferromanganese alloy had a chrome-magnesite brick crucible of 2050mm diameter and 960mm height. The medium-carbon ferromanganese was processed in a furnace having a magnesite brick crucible of 1800 mm diameter and 1335 mm height.

The furnace was operated at an average power between 0.2 and 1.0 MW for high and medium-carbon ferromanganese re-melting and smelting.

LABORATORY TESTWORK

Quantitative chemical analyses of metallic and oxide elements in the bulk jigged material showed poor accuracy. Comprehensive laboratory melting testwork was thus carried out to provide useful data for the pilot plant campaigns.

Melting tests were carried out in a 60 kVA induction furnace. An alumina crucible containing 100 grams of jigged metal fines was heated to 1400°C in an argon atmosphere and held at this temperature for 10 minutes. The melted products were thereafter allowed to cool inside the furnace. In general, jigged material starts melting around 1250°C. Solid products were separated into metal and slag portions. Each portion was then weighed and chemically analysed.

Metal portion

The metal portion constituted between 80 and 92% of the initial mass of jigged material. The chemical composition is presented in Table 1, together with the analysis of the bulk material. From the melting of jigged material, the alloy is seen to be slightly lower in Mn/Fe ratio, and higher in silicon content when compared to conventional ferromanganese metal.

	INPUT	OUTPUT	
	Jigged material	Metal	Slag
Mass, g	100.0	87.8	12.2
MnO, %	-	-	25.6
Fe ₂ O ₃ , %	-	-	0.2
SiO ₂ , %	-	-	36.3
MgO, %	0.6	-	4.1
CaO, %	4.7	-	28.4
Al ₂ O ₃ , %	0.6	-	5.4
Mn, %	64.9	74.7	-
Fe, %	13.3	16.2	-
Si, %	8.4	6.9	-
C, %	1.4	1.9	-
P, %	0.10	0.08	-

Table 1: Typical melting results for jigged material from a ferromanganese plant

Harmful impurities in the metallics

While the phosphorus content of the metal portion was always below ASTM specifications, concentrations as high as 0.30% were encountered.

Slag portion

The slag portion constituted between 8 and 20% of the initial mass of the melted jigged material. In most cases, it had a high manganese content with a predicted liquidus temperature above 1600°C. This type of slag needs to be modified with the addition of flux (lime) and or reductant (silicomanganese) to lower the liquidus temperature.

PILOT PLANT TESTWORK

Four testwork campaigns, investigating the re-melting and smelting of jiggged materials in a DC arc furnace, were carried out successfully with power fluxes varying between 200 and 300kW/m². The furnace power varied between 0.2 and 1 MW. These campaigns lasted from 7 to 22 days, and produced in total 370 tonnes of high-carbon and 43 tonnes of medium-carbon ferromanganese.

Furnace re-melting and smelting procedures

Materials were fed at a constant rate and the furnace energy input was adjusted to achieve the target operating temperature between 1400 and 1450°C.

The furnace recipe was designed to achieve less than 1% Si in the alloy, with a slag of acceptable composition and temperature. Changes to the working recipe were made, in order to achieve these objectives and minimize lime use.

The proportion of burnt lime in the initial batch composition was calculated to achieve a slag basicity index of 1.2 and thereafter to optimize lime utilization. The slag basicity index is defined here as $[(CaO + MgO)/SiO_2]$, mass ratio. The furnace was operated continuously (with feed and power on) for each specific condition to demonstrate the process. Beside minor variations to the working recipe, only feed rate and power were varied to maintain the operating temperature.

Metal and slag were tapped together through a single taphole at an average frequency of once every 2 hours or when judged necessary. For each tap, metal and slag samples were taken, whilst, for fume, a composite sample for each specific testwork condition was collected from the bag plant.

Atomic absorption and induction coupled plasma techniques were used to analyse the total amount of each element except for phosphorus and carbon where colorimetric

and combustion (Leco) methods were used, respectively.

EXPERIMENTAL RESULTS

The testwork results are shown in Tables 2 and 3.

	INPUT		OUTPUT		
	Jiggged material	Lime	HCFeMn	Slag	Fume
Mass, kg	1000	43	770	239	19
MnO, %	-	0.9		56.0	69.6
Fe ₂ O ₃ , %	-	0.2		3.7	5.0
SiO ₂ , %	-	1.7		20.9	7.4
MgO, %	0.4	1.4		1.6	0.8
CaO, %	1.3	93.6		17.4	4.1
Al ₂ O ₃ , %	0.5	0.5		1.8	0.5
Mn, %	72.6		75.6		
Fe, %	15.7		16.5		
Si, %	1.6		<1.0		
C, %	6.6		6.3		
P, %	0.10		0.10		

Table 2: Average composition of products from the re-melting of HCFeMn using lime as flux

Re-melting of HCFeMn jiggged metal fines

This process involved the re-melting of ferromanganese jiggged material whose metallic composition was closer to the market specifications for high carbon ferromanganese. The slag was modified to increase its fluidity. Tables 2 and 3 summarize the results of the testwork.

Smelting of HCFeMn jiggged metal fines

This involved the smelting of synthetic ferromanganese material having 6% silicon content, comprising jiggged material and silicomanganese fines. In order to minimize costs, the use of low value raw materials was also included in the investigation. Manganese bag house sludge and manganese ore fines were used for this purpose. The impact of ore manganese grade and Mn Fe ratio can be separately deduced.

	(1)				(2)				(3)				(4)							
	INPUT		OUTPUT		INPUT		OUTPUT		INPUT		OUTPUT		INPUT		OUTPUT					
	Jigged material	Si:Mn	Lime	HCFeMn	Slag	Fume	Jigged material	Si:Mn	Mn sludge	Lime	HCFeMn	Slag	Fume	Jigged Material	Si:Mn	Mn ore	Lime	HCFeMn	Slag	Fume
Mass, kg	1000	80	48	857	241	35	1000	1508	364	894	1768	29	1000	449	98	449	98	817	721	24
MnO ₂ %	-		0.9		34.5	67.2	-	39.3	1.0		35.8	25.7	-	62.1	1.0	62.1	1.0		52.7	41.3
Fe ₂ O ₃ %	-		0.2		1.3	4.3	-	2.8	0.4		1.6	9.7	-	15.3	0.4	15.3	0.4		3.7	7.0
SiO ₂ %	-		1.7		28.3	5.5	-	26.8	1.7		28.7	15.8	-	2.4	1.7	2.4	1.7		24.1	11.4
MgO %	0.4		1.4		1.9	0.8	0.4	4.3	1.3		4.0	5.3	0.4	0.7	1.3	0.7	1.3		1.3	2.4
CaO %	1.3		93.6		32.0	3.7	1.3	5.8	87.8		23.6	14.3	1.0	6.0	87.8	6.0	87.8		17.4	13.9
Al ₂ O ₃ %	0.5		0.5		1.7	0.3	<0.5	2.9	<0.5		2.8	1.2	<0.5	<0.5	<0.5	<0.5	<0.5		1.1	0.6
Mn ₂ %	72.6	62.2		76.4			70.3	66.8		73.5			73.3	63.5				74.8		
Fe %	15.7	12.9		16.2			15.5	13.6		18.4			15.8	13.3				20.3		
Si %	1.6	15.9		<1.0			6.3	15.9		1.5			2.0	15.8				<1.0		
C %	6.6	1.7		6.0			4.3	1.8		4.9			4.4	1.8				4.4		
P %	0.10	0.08		0.10			0.08	0.08		0.10			0.09	0.08				0.10		

Table 3: Average compositions of products from:

- (1) the re-melting of HCFeMn using flux and reductant (lime and silicomanganese)
- (2) the smelting of HCFeMn from synthetic jigged material containing 6% Si in metallics with manganese bag house dust sludge
- (3) the smelting of HCFeMn from synthetic jigged material containing 6% Si in metallics with manganese ore
- (4) the smelting of HCFeMn from synthetic jigged material containing 6% Si in metallics with manganese ore

Results are given in Table 3. Silicon removal was observed even with the use of low manganese grade materials, such as sludge.

The addition of silicomanganese was included to dilute harmful impurities and increase the grade of manganese in the metal.

Smelting of MCFeMn

The jiggged material supplied was a low carbon content product suitable for the smelting of medium-carbon ferromanganese. The selection of an appropriate manganese ore was an essential part of this exercise.

Dust from a ferromanganese refining plant was used since it had both a high Mn/Fe ratio and a high manganese grade which will promote manganese recovery at the expense of iron. Results of this testwork are presented in Table 4. Here it can be seen that the alloy produced met the specifications for medium-carbon ferromanganese.

	INPUT			OUTPUT		
	Jiggged material	dust	Lime	MCFeMn	Slag	Fume
Mass, kg	1000	350	170	977	578	12
MnO, %	-	-	2.8	-	34.5	50.9
Fe ₂ O ₃ , %	-	-	0.6	-	1.3	3.5
SiO ₂ , %	-	0.6	1.9	-	28.3	7.2
MgO, %	0.4	0.7	2.5	-	1.9	1.9
CaO, %	3.2	2.8	82.1	-	32.0	7.1
Al ₂ O ₃ , %	0.3	0.1	0.7	-	1.7	0.2
Mn, %	65.7	66.0	-	81.0		
Fe, %	12.6	1.7	-	15.4		
Si, %	8.6	-	-	<1.0		
C, %	1.5	0.3	-	1.5		
P, %	0.10	0.03	-	0.10		

Table 4: Smelting of Medium-Carbon Ferromanganese

DISCUSSION OF THE SMELTING RESULTS

For each series of testwork, the quality of metal produced was fairly constant and independent of minor fluctuations in slag compositions. The process showed little sensitivity as far as metal composition was concerned for small parameter changes of feed rates, temperature and pressure. Even sludge material low in manganese oxide proved to be effective for silicon removal.

It was further observed that variations in the slag basicity index had only a slight impact on metal composition.

High-Carbon Ferromanganese

During re-melting, the Mn/Fe ratio of the metal portion decreased slightly as a result of manganese losses to the fume and the reduction of more iron than manganese from the slag portion.

An evaluation of testwork yielded the following for high-carbon ferromanganese production:

Addition of silicomanganese to the re-melting recipe

This had been carried out to increase the slag fluidity. Some refinement of the metal was also achieved. Alloy manganese grade was improved but with an increase in iron recovery. The competition between the reduction reactions of manganese and iron, is an important factor for the re-melting and smelting. For a constant slag basicity index, an increase of silicon in the initial metal phase increased the recovery of iron and manganese to the alloy. Silicon addition to the metal portion, up to two to four times its initial composition, did not significantly change the metal composition with regard to iron and manganese contents. This is most likely as a result of an increase in the silicon activity coefficient, while iron and manganese activity coefficients remain

almost constant according to the work of Li *et al*¹². Any decrease in the group activity coefficient is followed with a decrease in the distribution coefficient of manganese and iron. This can be seen from Figures 2 and 3. Figure 4 shows that silicon distribution also decreases.

From these figures, it can be deduced that an increase in slag basicity index will likely produce a decrease in manganese and an increase in silicon distribution. This was also observed by Turkdogan and Hancock¹³. However, iron seemed insensitive, probably because this element was almost completely reduced in the testwork.

Smelting and refining of jiggged material

The smelting of jiggged material having a variable silicon content is subjected to the same considerations. From Table 3, for a given jiggged material, one can deduce that ore manganese grade, and Mn/Fe ratio play an important role in the alloy composition.

Although sludge material had a higher Mn/Fe ratio, the alloy manganese grade was lower compared to smelting tests using manganese ore. This suggests that manganese grade has a role to play in the kinetics of manganese reduction to the alloy.

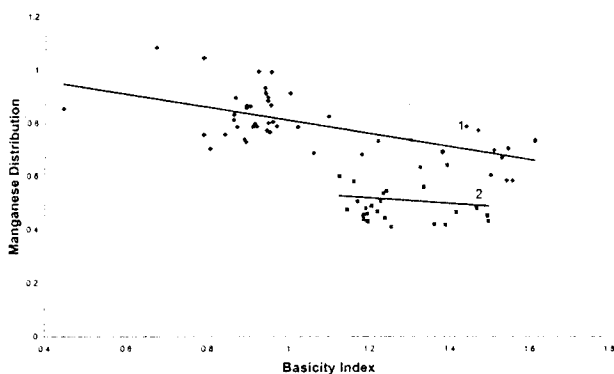

Figure 2: Manganese distribution versus basicity index for remelting with 1: lime as slag modifier; 2: lime and silicomanganese as slag modifier

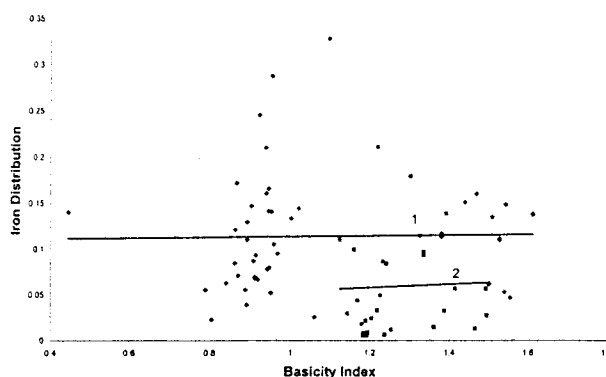

Figure 3: Iron distribution versus basicity index for remelting with 1: lime as slag modifier; 2: lime and silicomanganese as slag modifier

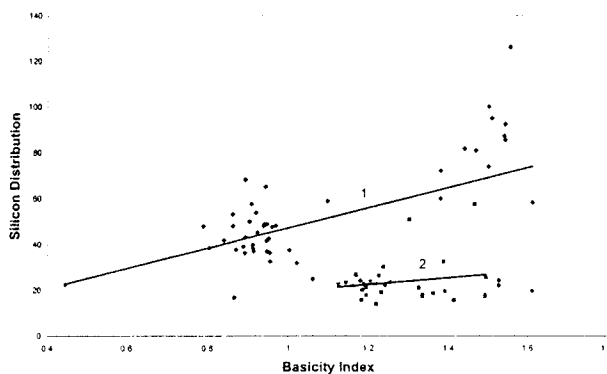

Figure 4: Silicon distribution versus basicity index for remelting with 1: lime as slag modifier; 2: lime and silicomanganese as slag modifier

The impact of silicon contained in the jiggged material on the alloy manganese grade was also observed in other testwork results, which are not included in this paper. A better appreciation can be drawn from Table 5 where the combined effect of ore Mn/Fe ratio and silicon contained in the metal portion, on the alloy composition can be seen. These results were simulated using Pyrosim computer software for the calculation of steady-state mass and energy balances¹⁴. The results were calculated considering a manganese ore containing

51% (Mn+Fe). The recoveries to the alloy for Mn and Fe are also shown. The alloy silicon target was around 1%, and slag basicity index was 1.2. Iron and manganese levels in the alloy are related to the metal portion and manganese ore compositions.

The following conclusions can be drawn from Table 5:

For the smelting of jigged material containing a given silicon content in the metal portion, alloy manganese grade increases whilst iron grade decreases with an increase of ore Mn/Fe ratio.

For a lower value of ore Mn/Fe ratio, an increase of silicon in the metal portion of jigged material increases alloy manganese grade up to a maximum, and then a decrease is observed. However, for a value of 20, an almost unchanged alloy manganese grade and a slight decrease in iron grade are observed.

An increase of manganese recovery to the metal is observed with an increase in ore Mn/Fe ratio.

From the above observations, it can be said that the refining of an alloy (increase of Mn grade) whose principles are similar to the simulated smelting process, will be promoted with a higher ore Mn/Fe ratio, manganese grade. The higher the silicon is in the smelting or refining recipe, the higher these two parameters must be.

During smelting at a constant slag basicity index, the manganese ore / jigged material ratio is fixed by the targeted alloy silicon content, the initial silicon content in the metal portion of the jigged material, and the ore composition. At a fixed silicon content in the crude alloy and a given manganese ore, this ratio will increase along with silicon content in the metal portion of jigged

material. An increase of manganese ore / jigged material ratio decreases manganese recovery to the metal. These are shown in Figures 5 and 6.

1	Si ⁰ in jigged, %	7.35	4.00	2.00
	Mn in alloy, %	75.30	76.12	76.73
	Fe in alloy, %	18.55	17.81	17.24
	R _{Mn} , %	71.78	79.90	86.65
	R _{Fe} , %	99.93	99.95	99.97
2	Slag/Metal ratio	0.89	0.57	0.34
	Mn in alloy, %	76.16	76.59	76.91
	Fe in alloy, %	17.68	17.35	17.06
	R _{Mn} , %	71.95	80.00	86.67
	R _{Fe} , %	99.93	99.95	99.97
3	Slag/Metal ratio	0.89	0.57	0.34
	Mn in alloy, %	77.09	77.08	77.11
	Fe in alloy, %	16.72	16.85	16.86
	R _{Mn} , %	72.13	80.06	86.68
	R _{Fe} , %	99.93	99.95	99.97

Table 5: Alloy composition vs silicon content in metal portion and ore Mn/Fe ratio: 1=8.5; 2=11.9; 3=20

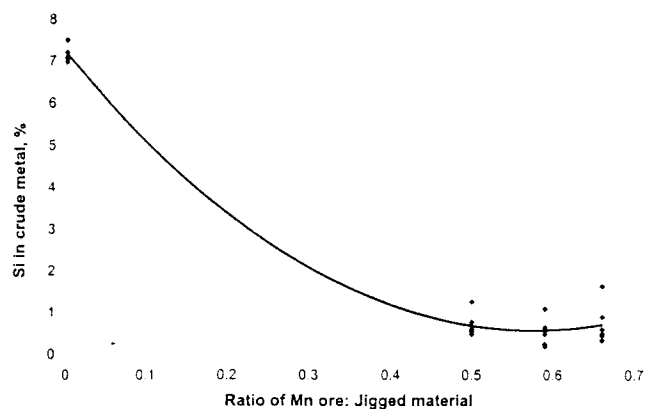

Figure 5: Si content in crude alloy vs Mn ore / jigged material ratio

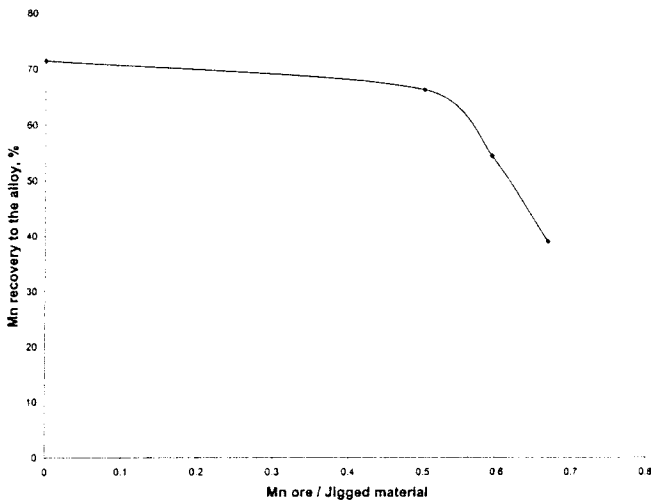

Figure 6: Mn recovery to the alloy vs Mn ore / jigged material ratio

Slag

The relation between slag manganese and iron oxides for high-carbon ferromanganese re-melting and smelting from jigged material is depicted in Figure 7. Plots 1, 2 and 3 concern re-melting and smelting using sludge and ore, respectively. For a similar basicity index and silicon content in the jigged material, the MnO content in the slag would depend on the ore composition.

Manganese oxide in the slag as a function of slag basicity index is presented in Figure 8 for the re-melting of jigged material. Compared to the situation where lime is used as a slag modifier, the addition of silicomanganese contributes to reduce substantially the level of manganese in the slag.

Combining Figures 7 and 8, it can be said that, for a constant slag basicity index and raw material composition, the level of manganese oxide in the slag would depend on the extent of reduction (which is represented by the iron oxide content). For a given jigged material composition, the reduction state in a given furnace atmosphere condition would depend

inherently on the manganese ore to jigged material ratio.

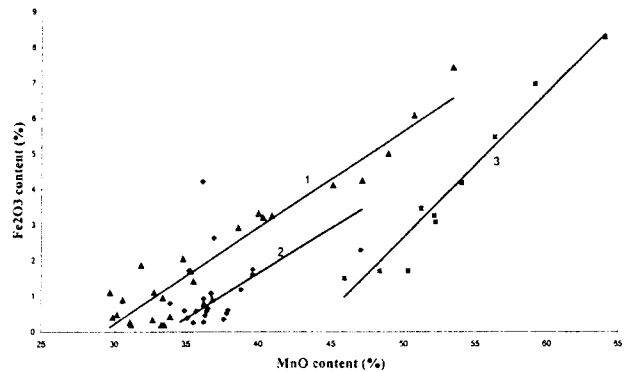

Figure 7: MnO versus Fe₂O₃ of the slag for 1: re-melting; 2: smelting using sludge; 3: smelting manganese ore

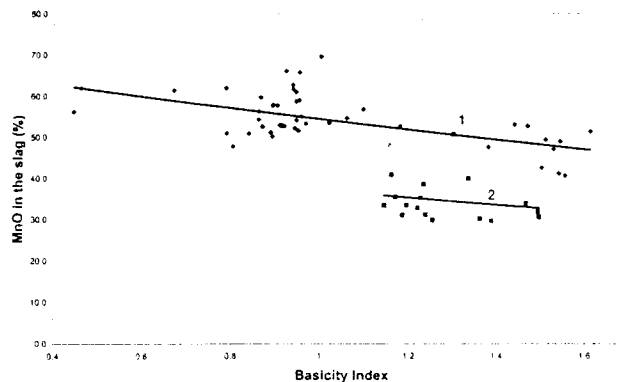

Figure 8: MnO vs Basicity Index of the re-melting process slag for: 1=lime as slag modifier; 2= lime + silicomanganese as slag modifier

Medium-Carbon Ferromanganese METAL COMPOSITION

The theoretical approach showed that raw materials and alloy compositions are related to a great extent. It was important to investigate this correlation prior to the smelting campaigns of medium-carbon ferromanganese. The investigations in this regard were carried using Pyrosim software.

Figures 9 and 10 depict the impact of manganese ore and jigged material composition on the alloy quality for a slag basicity index equivalent to 1.2. Figure 9 shows the smelting of jigged material containing 10% slag, and 4.5 Mn/Fe ratio, whilst Figure 10 shows the smelting of jigged material with various silicon contents in the metal portion using manganese ore having a Mn/Fe ratio of 10.

Influence of ore Mn/Fe ratio on the alloy quality

An increase in the ore Mn/Fe ratio increases the manganese content in the alloy. The impact is more pronounced at lower ratios, while, above 20, this impact seems to be negligible.

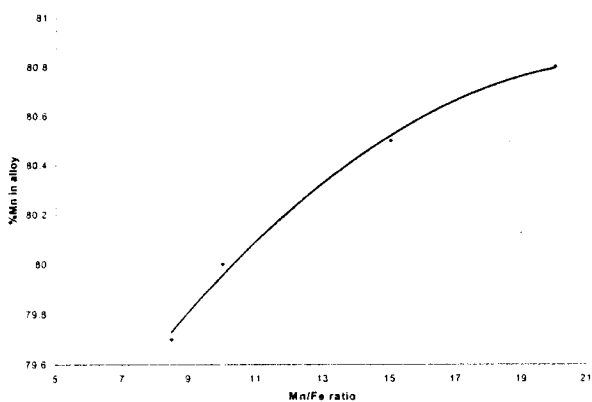

Figure 9: Ore Mn/Fe ratio vs alloy manganese grade

Influence of Mn/Fe ratio of metalics on the quality of the metal

A linear relation is seen here. The Mn/Fe ratio of the metalics compared to manganese ore seems to have a greater and more definitive impact on the alloy manganese grade. Unfortunately, it is not possible to increase this during the jigging process. The Mn/Fe ratio of the jigged product will give an indication of the minimum alloy manganese grade and will direct the choice of the smelting recipe especially the selection of manganese ore in order to produce a required alloy quality.

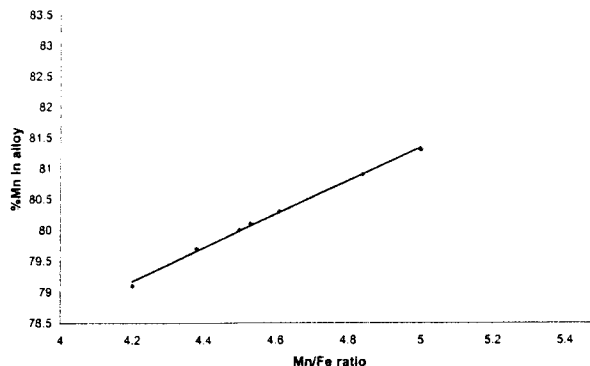

Figure 10: Metallic Mn/Fe ratio vs alloy manganese grade

MANGANESE LOSSES TO THE FUME

Re-melting and smelting of jigged material resulted in less than 1% of total manganese lost to the fume, which is very low compared to the carbothermic reduction of manganese ore.

TECHNO-ECONOMIC EVALUATION OF THE PROCESSING OF JIGGED MATERIALS IN A DC ARC FURNACE

Compared to the carbothermic production of either high or medium-carbon ferromanganese alloy, three important elements contribute to make this process cost-effective, namely the consumption of energy and electrodes and the cost of the raw materials. Measurements carried out during the testwork provided figures for energy consumption less than 1MWh/ton alloy, and electrode consumption less than 2.5 kg/MWh. This is far lower than for the carbothermic production of manganese alloys which consumes between 2650 and 3600kWh / tonne alloy¹. The cost of production of jigged material is relatively low since neither mining nor agglomeration or roasting is required.

PROCESS IMPLICATION

An incorporation of the jigging process and DC arc furnace in a ferromanganese plant was investigated.

Two flow sheets were considered: the

fluxless process and the basic process plants. For both flow sheets, the advantage of a jiggling plant is clear since it produces additional metal. This metal will come from the processing of jiggged material and also from the direct re-melting of all metal fines generated during the crushing of the final alloys

However, the incorporation of a DC arc furnace in an operation based on a fluxless method will produce medium-carbon manganese alloys besides high-carbon and silicomanganese.

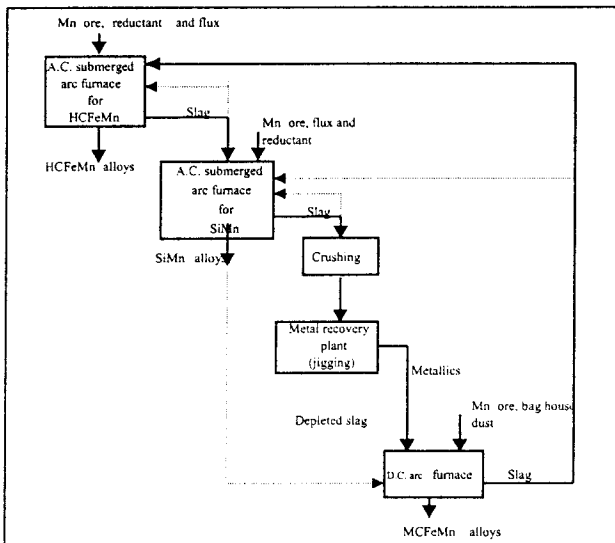

Figure 11: Incorporation of the jiggling process and a DC arc furnace in a fluxless plant

Incorporation in the basic process offers fewer advantages in term of diversification of products but still increases the overall production.

The proposed flowsheet based on the fluxless method as presented on Figure 11 will allow:

- the recovery of metallics with the jiggling process,
- the re-melting and smelting of jiggged metal fines into saleable alloy,
- the use of low-value manganese ore such as fines or dust as components of the feed material,
- the use of rich slag generated from the smelting of low-value manganese ore fines or dust as raw material in the manganese carbothermic reduction in an AC furnace,
- an easy re-melting of fines generated from crushing of final products.

The following benefits can be obtained:

- increase of the reserve lifetime as the slag dump can be considered as an additional reserve,
- increase the flexibility of the agglomeration and furnace operation with the reduction of the amount of fines and slag recycle,
- increase of smelting rate of the AC submerged arc furnaces, and increase of the agglomeration capacity, resulting in an increase of the overall metal production,
- increase of the plant material utilization,
- increase of the overall plant manganese recovery.
- All the above will give an increase in the metal production and a reduction in the operating costs.

CONCLUSIONS

The feasibility of re-melting and smelting of ferromanganese jiggged material in a DC arc furnace, to produce saleable ferromanganese alloy, was proved at a 1MW scale. Ferromanganese alloys according to the ASTM specifications for high and medium-carbon ferromanganese were produced successfully.

The incorporation of a jiggling process combined with a DC arc furnace showed

that it is a viable complement to existing ferromanganese plants to increase the production and reduce the operating costs.

Huge stockpiles of slag in most plants worldwide can make it possible to design a plant of appropriate size and throughput. A toll treatment of the slag dump could also be a viable alternative.

REFERENCES

1. Elyutin VP *et al.* *Production of Ferroalloys Electrometallurgy*, The State Scientific and Technical Publishing House for Literature on Ferrous and Non-ferrous Metallurgy, Second Revised and Completed Edition, Moscow 1957, pp. 114, 118.
2. Olivier BJ, Guest RN and Parker JAL *The Production of Ferroalloys by the Toll Treatment of Slag Dumps*, Infacon 8, Beijing, China 1998, pp.171 - 175
3. Curr TR *et al.* *U.S. Patent 4540433*, (filed 10.09.1985)
4. Weizhong Ding and Sverre E. Olsen, *Reaction Equilibria in the Production of Manganese Ferroalloys*, Metall. Mater. Trans. B, 1996, Vol. 27B, 5 - 17
5. Ding Weizhong, Xu Weiwei, Tang Kai and Jiang Guochang, *Optimization of Medium- and Low-Carbon Ferromanganese Process by Silicothermic Reduction*, Infacon 8, Beijing, China 98, pp. 221 - 225
6. Kucukkaragoz C. Sedar and Eric Rauf Hurman, *Equilibria Between Refined Ferromanganese / Silicomanganese Alloys and Silicate Slags*, Infacon 8, Beijing, China 98, pp. 306 - 307
7. Hiroki Ahta and Hideaki Suito, *Activities in MnO-SiO₂-Al₂O₃ Slags and Deoxidation Equilibria of Mn and Si*, Metall. Mater. Trans. B, 1996, Vol. 27B, 263 - 270
8. Swinbourne DR, Rankin WJ and Eric RH. *The Effect of Alumina in Slag on Manganese and Silicon Distributions in Silicomanganese Smelting*, Metall. Mater. Trans. B, 1995, Vol. 26B, 59 - 65
9. Rankin WJ. *Si-Mn equilibrium in ferromanganese alloy production*, Trans. Inst. Min. Met. Sec. C, 1979, pp. 167 - 174
10. Jones RT, Barcza NA, and Curr TR. *Plasma Developments in Africa*, Second International Plasma Symposium: World Progress in Plasma Applications (Palo Alto, CA:EPRI, 1993)
11. Jones RT, Haymann DA, and Denton GM. *Recovery of Cobalt, Nickel, and Copper from Slags, using DC arc furnace technology*, International Symposium on Challenges of Process Intensification (Montreal: CIM, 1996), pp 451-466
12. Honjie Li *et al.* *Evaluation of Unified Interaction Parameters for Calculating Activities of Ferromanganese Alloys: Mn-Fe-C, Mn-Fe-Si, Mn-C-Si, and Mn-Fe-C-Si Systems* Metall. Mater. Trans. B, 1997, Vol. 28B, 553 - 562
13. Turkdogan ET and Hancock RA. *Equilibrium Measurements between Carbon-Saturated Mn-Fe-Si Melts and CaO-Al₂O₃-MnO-SiO₂ Slags*, Trans. Inst. Min. Met. Sec. C, 1958
14. Jones RT, *Computer Simulation of Pyrometallurgical Processes*, APCOM 87, Proceedings of the Twentieth International Symposium on the Application of Mathematics and Computers in the Mineral Industries, Volume 2: Metallurgy (Johannesburg, South Africa: SAIMM, 1987), pp. 265-279